

GTR-56

Generator Controller

Manual



Web Site : <http://www.monicon.com.tw>

E-mail : sales@monicon.com.tw

Introduction

1、GTR-56 Panel



Fig.1 GTR-56 Panel

Indicators

- ◆ Power
- ◆ Run
- ◆ Low Fuel Level
- ◆ Low Frequency
- ◆ Emergency Stop
- ◆ Low Battery
- ◆ Over Crank
- ◆ Over Speed
- ◆ High Water Temp.
- ◆ Low Oil Pressure
- ◆ Alarm

Key Switch Function

- ◆ **ATS**
When ATS input is activated, the engine starts automatically.
- ◆ **Manual**
User starts the engine directly.
- ◆ **Off**
User shuts down the engine or forbid to start function.

Buttons Function

- ◆ **Reset**
 1. First time “Reset” shuts down the alarm. Second time “Reset” clears fault lights.
 2. Holding down for a longer period will produce 1st and 2nd time “Reset” functions.
- ◆ **Light Test**

Test lights for solid, clear, brightness and alarm.

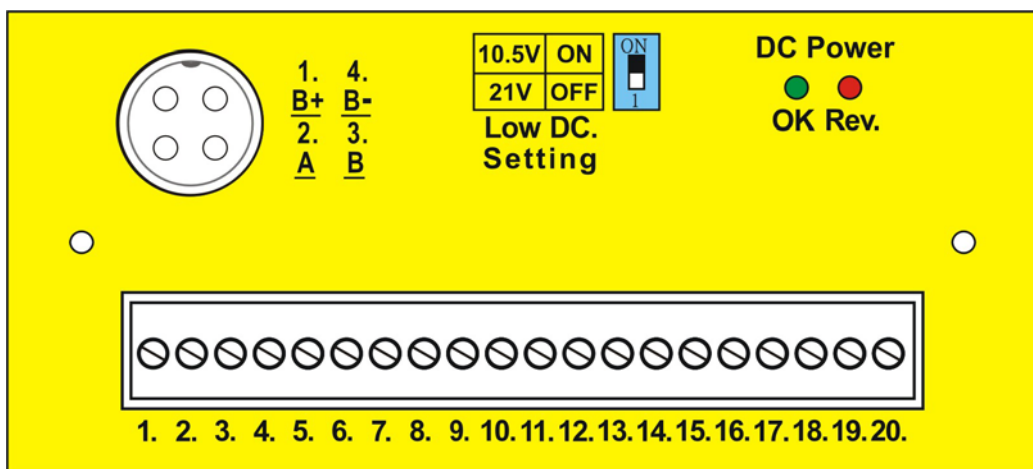

2、Wire Terminal



GTR-56 wire terminal

GTR-56 Terminal

Europium style Connector	Number	Code	Description
	1	GND	Ground (Battery -)
	2	Battery +	DC supply (Battery +)
	3	Em. Cut	Emergency cut
	4	Fuel	Fuel Valve output
	5	Motor	Starter Motor output
	6	Output 1	Auxiliary output 1
	7	Alarm	Alarm output
	8	Output 2	Auxiliary output 2
	9	L.O.P	L.O.P. input
	10	H.W.T.	H.W.T. input
	11	Input 0	Auxiliary Input 0
	12	Input 1	Auxiliary Input 1
	13	ATS	ATS input
	14	F.D. 1	Frequency detect input 1
	15	F.D. 2	Frequency detect input 2
	16	No use	No use
	17	Output 3	Auxiliary output 3
	18	No use	No use
	19	Input 3	Auxiliary input 3
20	No use	No use	

 OK / O.V.	OK: Solid "green" LED display O.V.: Solid "red" LED display
 Reverse	Polarity fault
	RS-485 Communication Port

[1] The output voltage depends on the voltage of DC supply (+12V or +24V).

[2] Output function can be changed according to user's requirements.

3、CASE DIMENSIONS

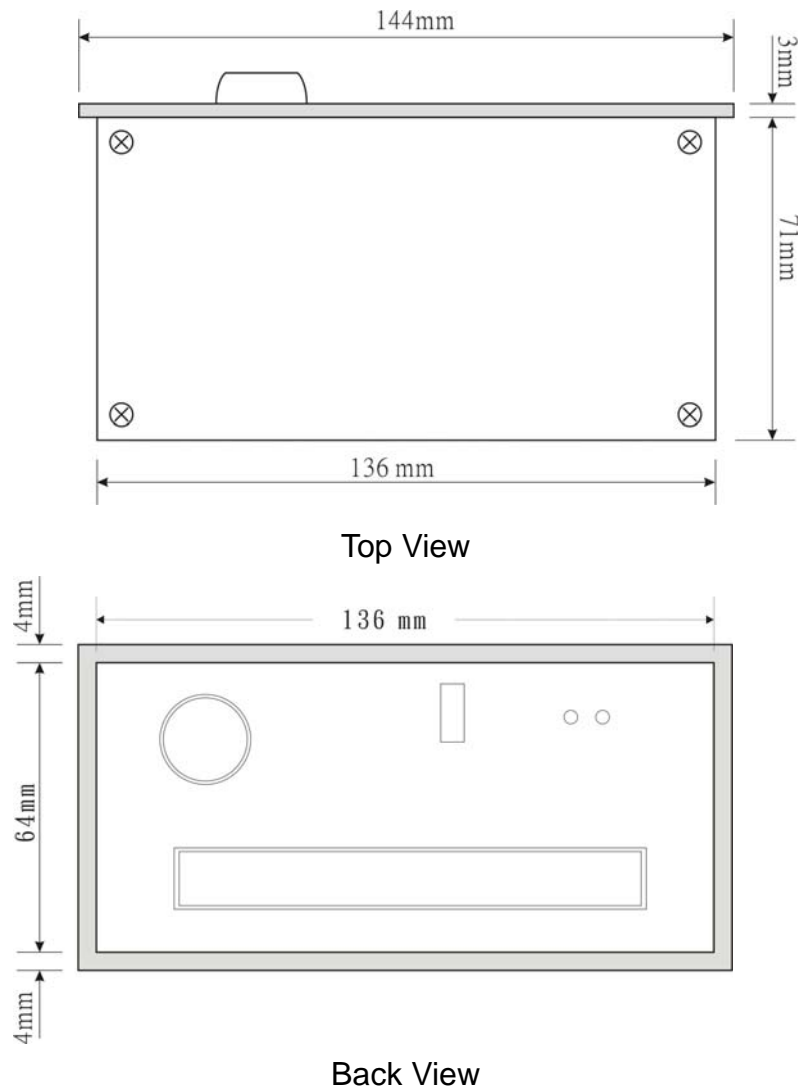

Specifications

1、General

DC Supply:

8 ~ 36 VDC

Power Consumption:

Max. 10 W

Measuring Frequency:

0 ~ 80 Hz (Min AC Volt: 10 V)

Relay Output:

10 A /30 VDC

Software Platforms:

Windows 98, Windows ME, Windows 2000, Windows XP (recommend)

Communication Protocol:

RS-485 (Dynamic encryption by Monicon technology)

Operating Temperature Range:

-30 °C ~ +70 °C

Dimension (W x H x D):

144 mm x 72 mm x 74 mm

Panel Cut-out (W x H):

138 mm x 67 mm

Weight:

0.63 Kg (1.39 lb.)

2、Controller Function

General Function:

Network function:

- ◆ Remote start/stop the controller by network circuitry
- ◆ Parameter setting and reading
- ◆ Input and output monitoring
- ◆ Fault history readout

Panel function:

- ◆ Manual start / stop engine.
- ◆ Automatically start / stop engine by ATS.
- ◆ Reset the Genset.
- ◆ Light test.

Protection function:

Engine respect:

- ◆ Over crank protection
- ◆ Low oil pressure protection
- ◆ High water temperature protection
- ◆ Over speed protection

Generator respect:

- ◆ High frequency protection
- ◆ Low frequency protection

Peripheral respect:

- ◆ Lower fuel level protection
- ◆ Aux. Input (such as Emergency Stop)

Wiring

1、Wiring example

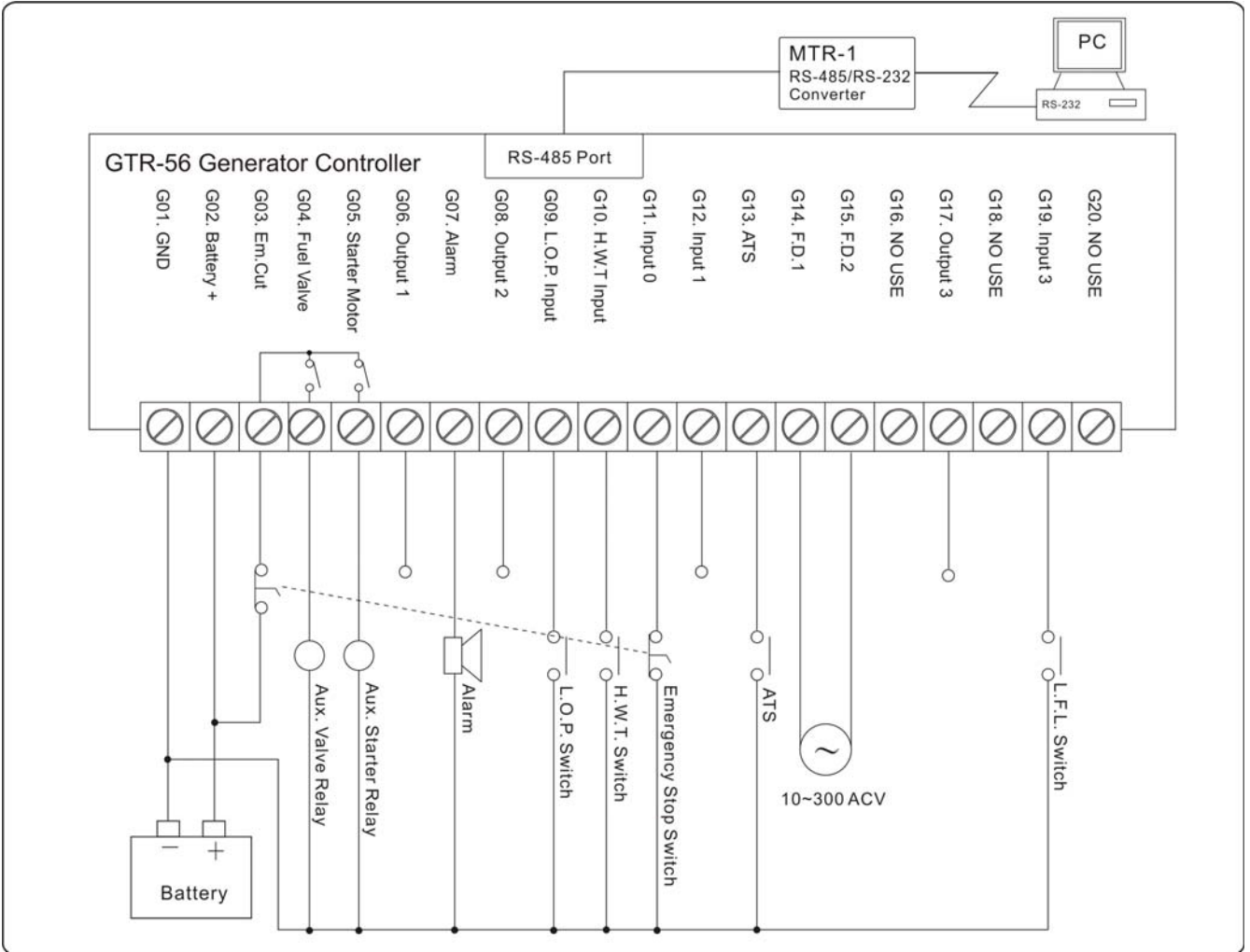

2、Connection in short distance

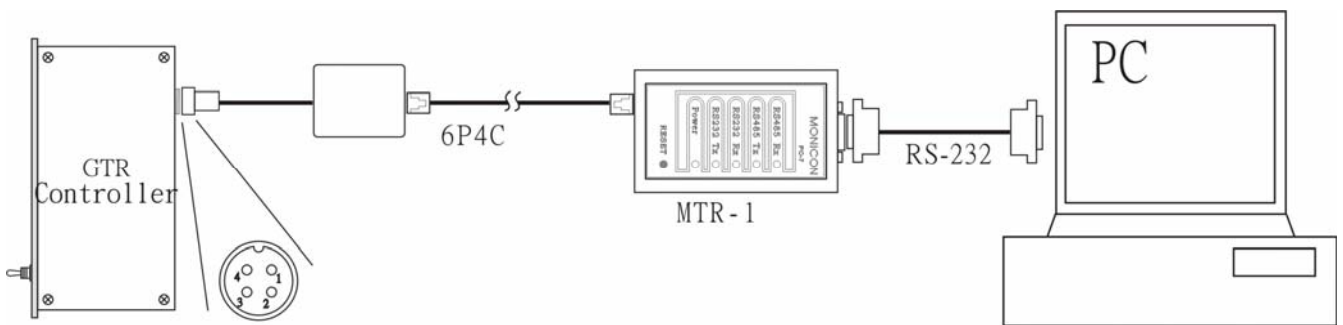

3、Connection with modem

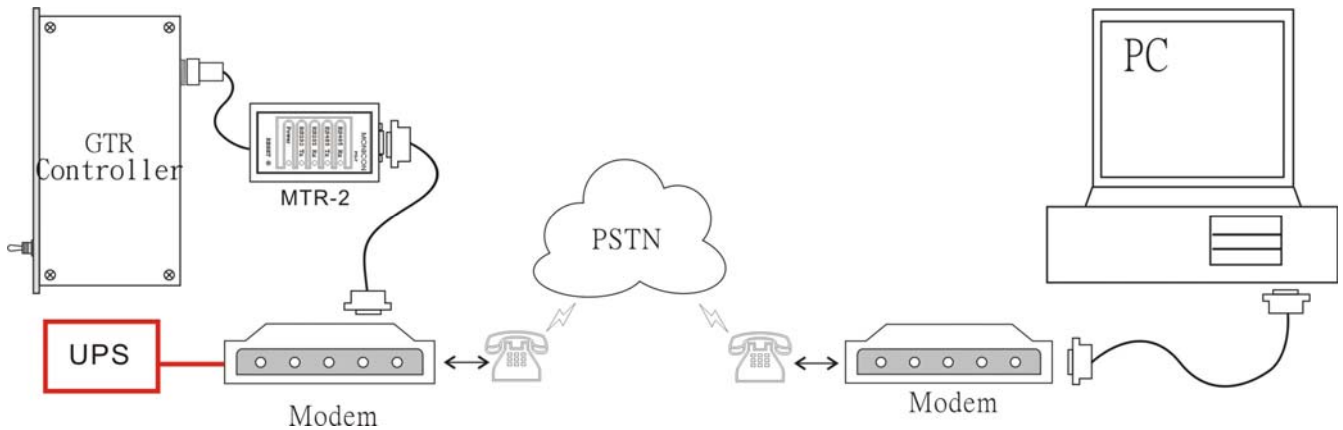

4、Inside fuse and protecting value

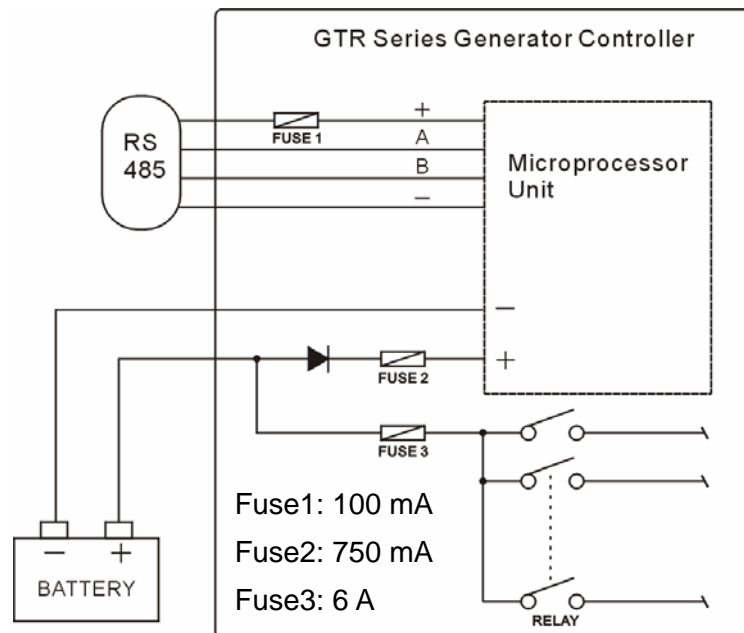

5、Group connection

- ◆ Every controller must have its own identified number to support recognition by software. Go to System / Misc. page, and change its id number.
- ◆ Group wiring :
The MTR-1 terminal pin 1 and pin 4 are the power supplied ports, so only one MTR-1 needs to be connected with pin 1,2,3,4. The others connect with pin 2, 3.

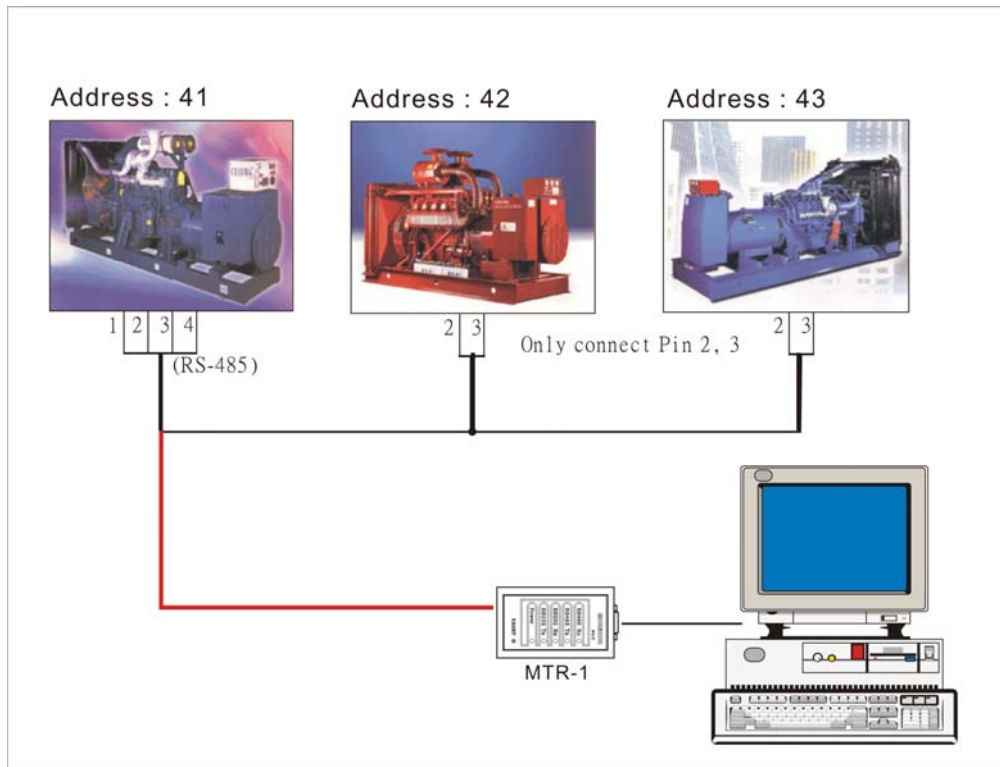

*It is strong suggestion that using another power source to power the communication card (MTR-1), If the wire length over 25 meters. That prevents the MTR-1 go in unpredictable condition by voltage drop.

GTR Series Software Installation

6、GTR-52 Software Installation Procedure

Step 1 :

Insert the installation disc in the CD ROM drive, and then choose the folder "GTR52", double-click "Setup.exe". The wizard will guide you to finish whole setups.

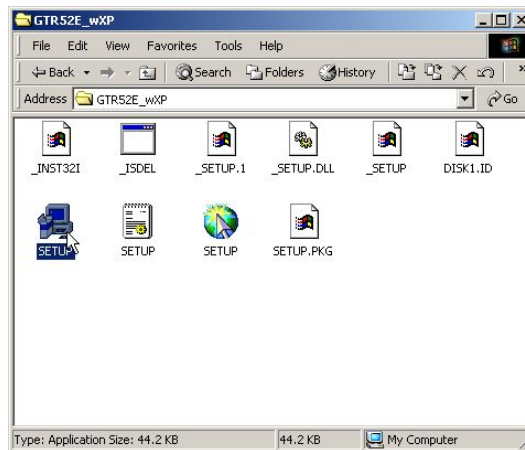

Step 2 :

Welcome Screen

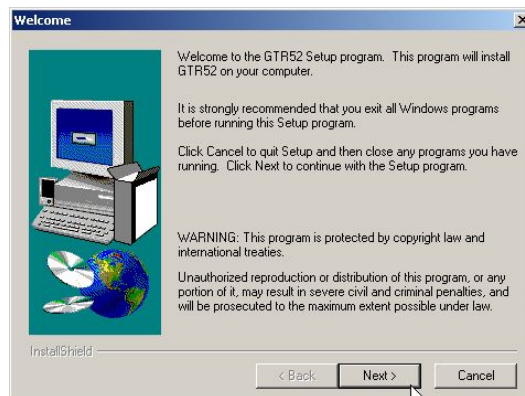

Step 3 :

Choose Destination Location

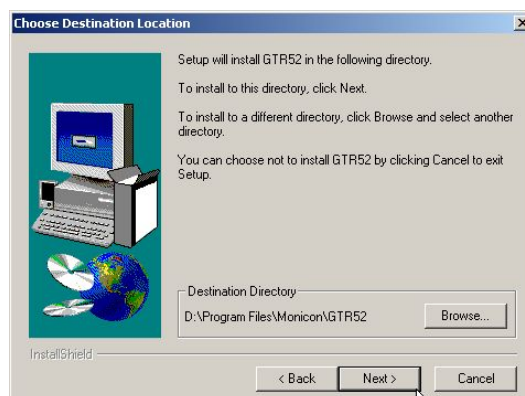

Step 4 :

Select Program Folder

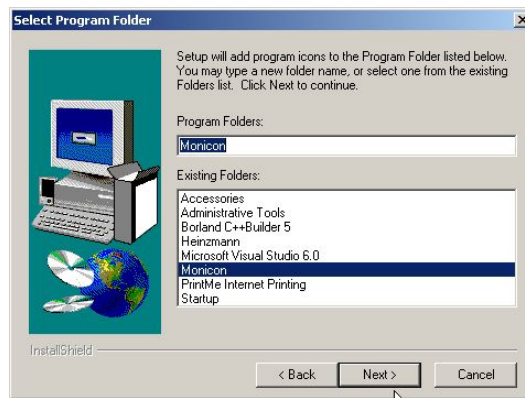

Step 5 :

Restart Windows



7、Software Manual Button Description



『Connection』

The connection-setting window will display after click “Connection” button. User have to set comport, connection method and controller ID. Click the “connect” button activates the communication between controller and computer.

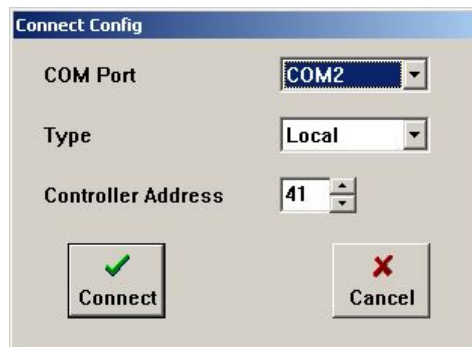

Local connection setting window

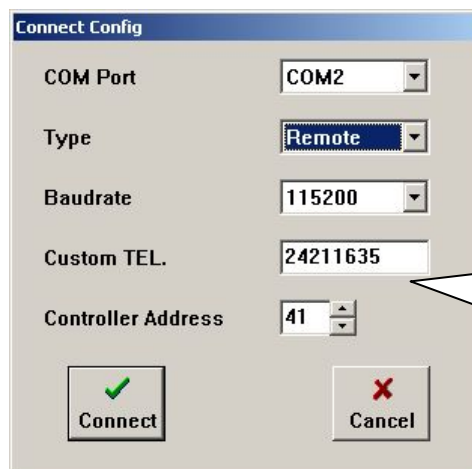

Modem connection setting window

User have to fill baud rate, phone number when using Modem as connection facility.



『Disconnection』

Push this button can cut off connection between computer & controller.



『Open an exist file』

Open an exist configuration file of GTR-52. It is convenience for configure GTR controller with same requirement.

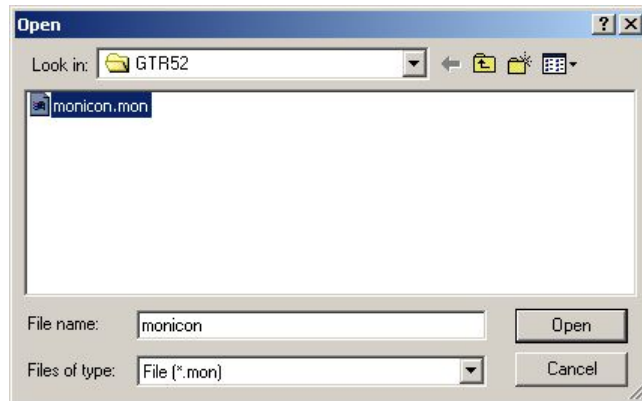
『 Save parameter in a file 』

Save all parameters in to a file as a record or a configuration library.

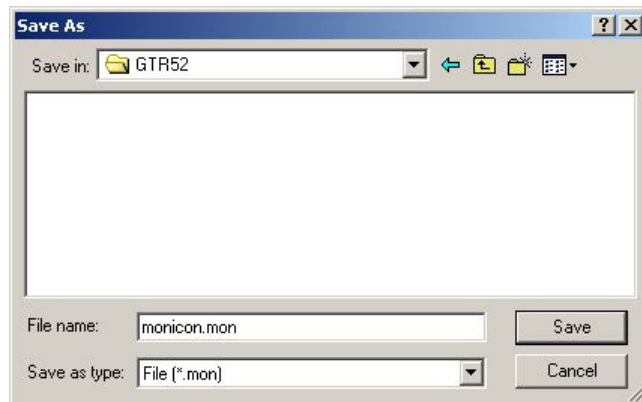
『 Remote Start 』

When the communication between GTR52 and software is setup, User can start engine by 2 ways.

- 1 Enable Running Interval timer and then click OK. The engine will start at next second, and will be stop until timer expired.
- 2 Click OK directly, then the engine will start, and will be stop if communication failed or click stop button.

(Note: communication may fail by many reasons, so it is strong suggestion that using Method 1 to start engine)

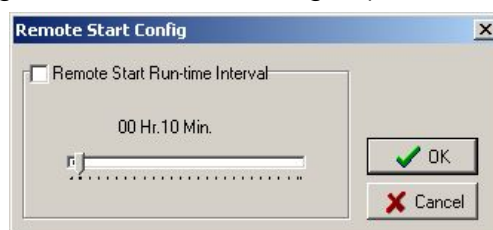

**『 Remote Shutdown 』**

Click this button shuts down the running engine that by network remote start.

**『 Reset 』**

Click this button clears fault status.

**『 Fault Record 』**

Read the newest 16 fault record.

**『 Read All Parameter 』**

Read all parameters from controller.

**『 Set All Parameter 』**

Write all parameters into controller.

**『 About 』**

Display Information of “Monicon” company, and software version.

**『 Read Parameter 』**

Click this button reads parameters back from controller while connection is established.

**『 Setting Parameter 』**

Click this button writes parameters into controller while connection is established.

**『 Parameter Re-Flash 』**

After user writes parameters in to controller, the parameters are in un-working memory until clicks this button. All parameters will be loaded in the run procure.

**『 Message Clear 』**

Click this button clears the text in message window.

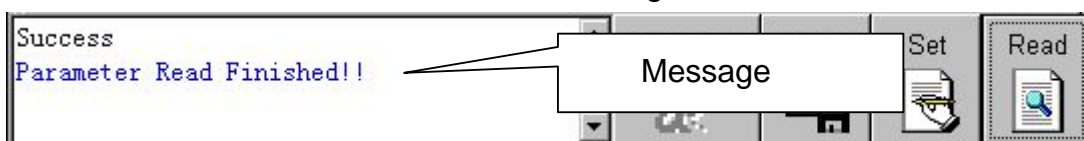

Parameter Screen Description

1、 『System』 Page

『Crank』 page

➤ Parameter Screen

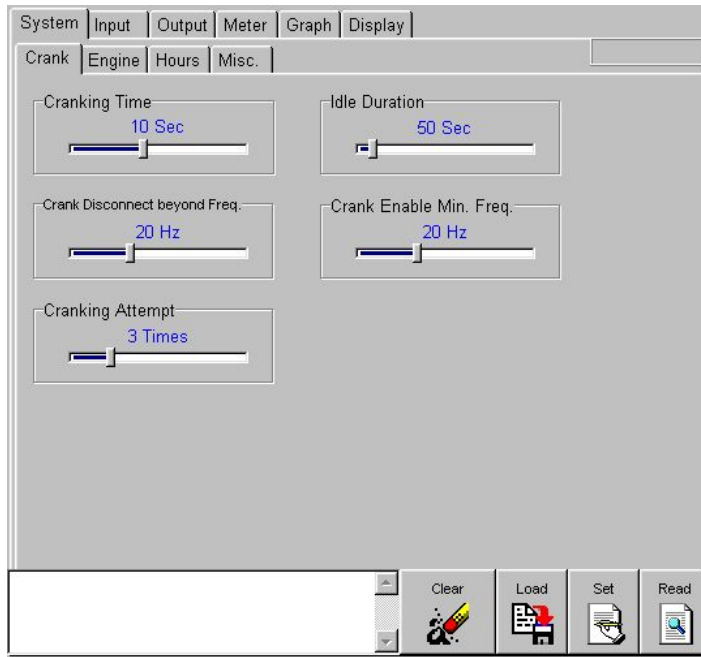

➤ Parameter Item

Crank Parameter			
Parameter name	Default	Range	Description
Cranking time	10 Sec	3~20	Set the maximum limitation of the cranking time.
Idle Duration	50 Sec	5~600	The interval of idle running.
Crank disconnect beyond frequency	20 Hz	15~30	When frequency goes above this setting, the starter motor will escape.
Crank enable minimum frequency	20 Hz	15~30	When frequency is below this setting, the starter motor will be activated during cranking interval.
Cranking Attempt	3 Attempt	1~10	Total cranking attempts.

『Engine』 Page

➤ Parameter Screen

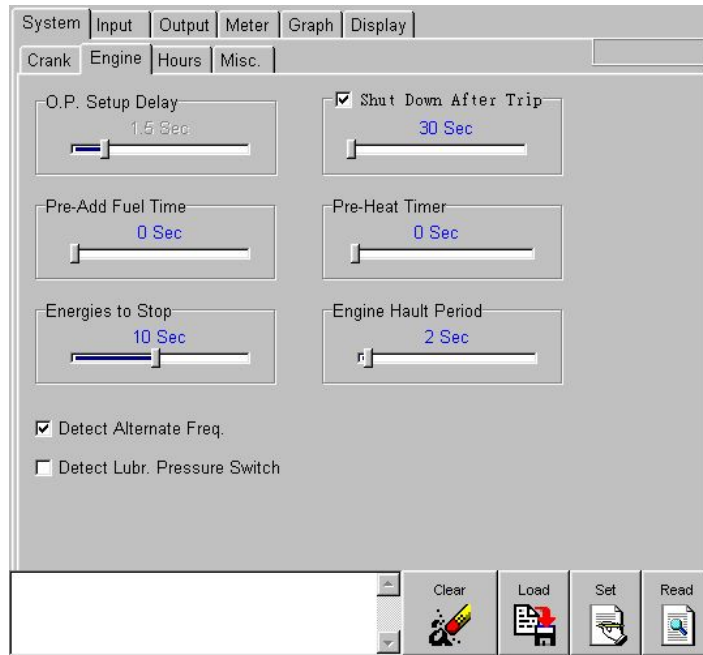

➤ Parameter Item

Engine Parameter			
Parameter name	Default	Range	Description
Pre-Add Fuel Time	0 Sec.	0~10	The time of driving the fuel valve before start Engine.
Engine halt period	2 Sec.	1~30	Engine will be halt a period of time before restart engine
Shutdown After Trip	30 Sec.	30~900	When trip occurred the Run light will flash and trip relay energized, the controller will shut down the engine if the fault is not clear before the setting time is up.
Energies to stop	10 Sec.	1~20	The timer is setting how long the fuel solenoid should be energized to stop the engine completely.
Pre-Heat Timer	0 Sec.	0~60	The Pre-Heat procedure will be added and AUX. Output will be activated if designated.
O.P. Setup Delay	1.5 Sec	0.5 ~ 6.25	If the system's setting "Detect Lubricant Pressure sw." is enabled, when oil pressure switch is activated and the active period is longer than this setting, the controller will escape the starter motor during crank interval. This setting is nothing to do with low oil pressure delay.
Detect Alternate frequency	Enable	Enable/Disable	Escape starter motor by frequency.
Detect Lubricant pressure sw.	Disable	Enable/Disable	Escape starter motor by lubricant pressure built up.

『Run Hour』 Page

➤ Parameter Screen

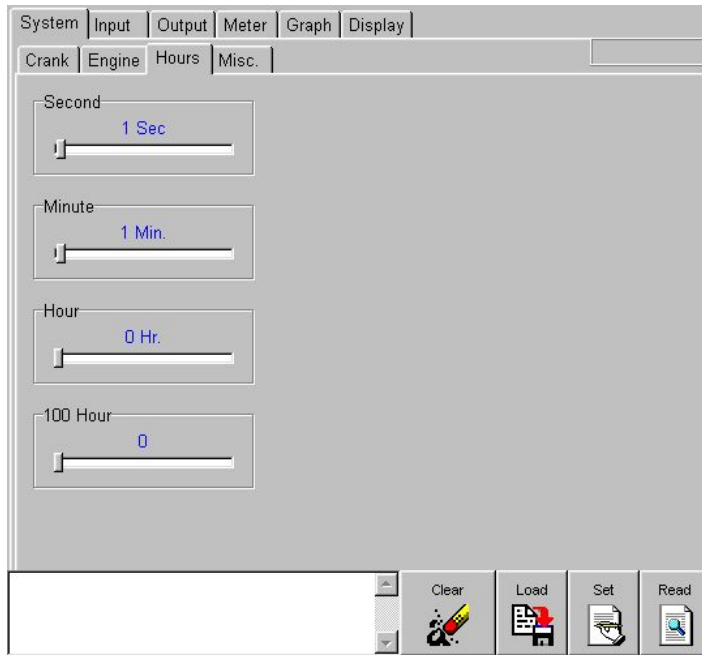

➤ Parameter Item

Run Hour Parameter			
Parameter name	Range	Default	Description
Second	0~59	0	Sets Running Hour meter "Second" Value.
Minute	0~59	0	Sets Running Hour meter "Minute" Value.
Hour	0~99	0	Sets Running Hour meter "Hour" Value.
100 Hour	0~99	0	Sets Running Hour meter "100 Hour" Value.

『Miscellaneous』 Page

➤ Parameter Screen

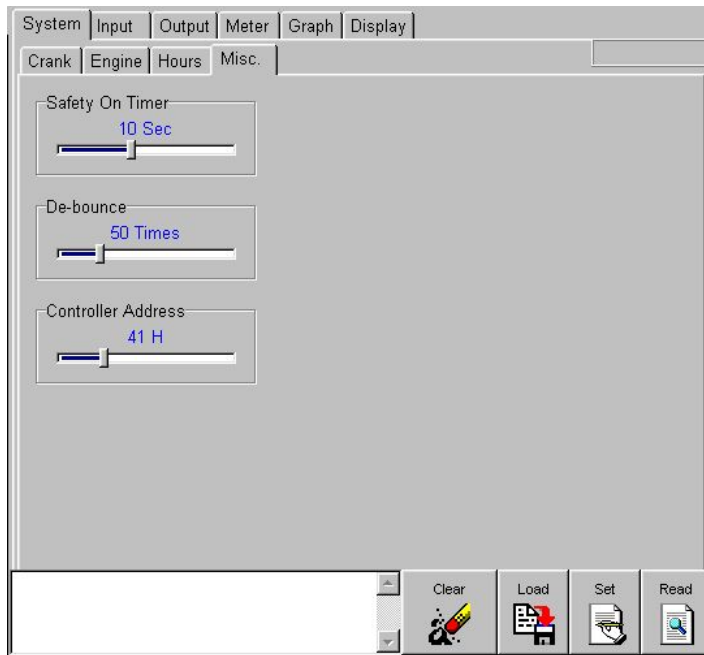

➤ Parameter Item

Misc. Parameter			
Parameter name	Default	Range	Description
Safety On Timer	10 Sec.	3~20	All alarms are ignored until safety on timer expired, except the emergency stop, and over speed.
De-bounce	50 Attempts	5~200	De bounce time can avoid the interference by electronic or magnetic.
Controller Address	41 H	01~FF	Controller address is for identification while multiple controllers connect in one network.

2、 『 Input 』 Page

『 Sensor Switch 』 Page

➤ Parameter Screen

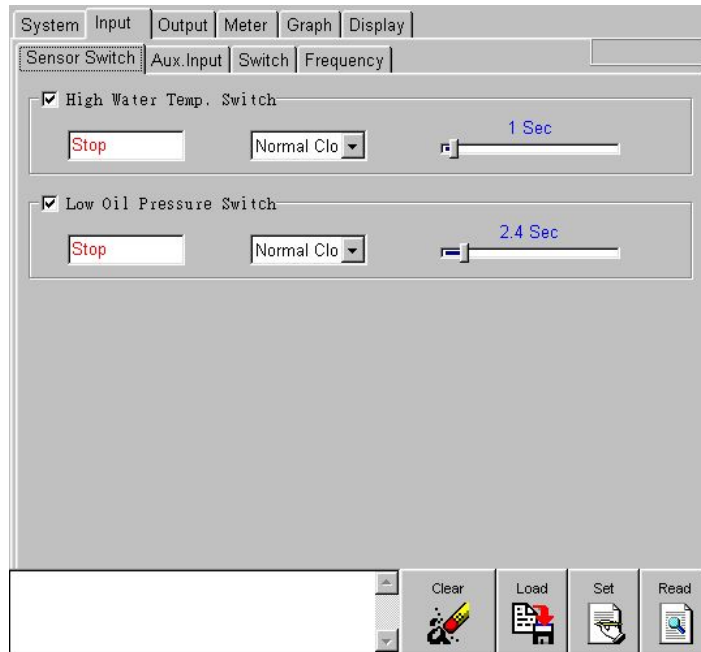

➤ Parameter Item

High Water Temp. Switch Parameter			
Parameter name	Default	Range	Description
Enable	Enable	Enable/Disable	Check means enable this function.
Action Mode	Shutdown	Shutdown	Shut down the engine after condition meets the set up value.
Switch Type	N.O.	N.O./ N.C.	N.O. : This switch returns a closed signal during high water temp. occurred. N.C. : This switch returns an open signal during high water temp. occurred.
Delay Time	1 Sec.	0.25~50	Delay Time
Low Oil Pressure Switch Parameter			
Parameter name	Default	Range	Description
Enable	Enable	Enable/Disable	Check means enable this function.
Action Mode	Shutdown	Shutdown	Shut down the engine after condition meets the set up value.
Switch Type	N.O.	N.O./ N.C.	N.O. : This switch will return a closed signal during low oil pressure happen, once oil pressure is established the switch will open. N.C. : This switch will return an open signal during low oil pressure happen, once oil pressure is established the switch will close.
Delay Time	1.5 Sec.	0.2~40	Delay Time

『 Aux. Input 』 Page

➤ Parameter Screen

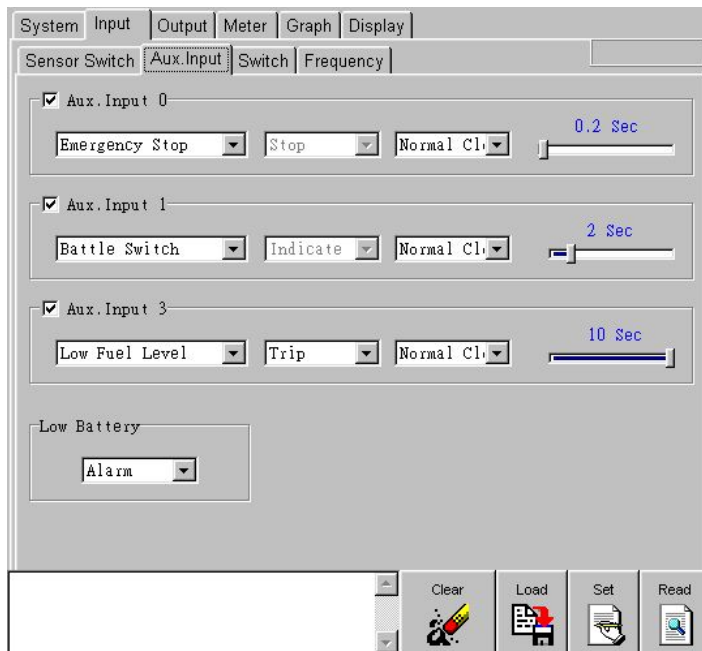

➤ Parameter Item

Aux. Input Parameter					
Parameter name	Enable	Name as	Action Mode	Switch Type	Timer
Aux. Input 0	Checked	Emergency Stop	Shutdown	N.C.	0.2 Sec
Aux. Input 1	Checked	Battle	Indicate	N.O.	1 Sec
Aux. Input 3	Checked	Low Fuel Level	Trip	N.O.	10 Sec
Low Battery			Alarm / Indicate		
Descriptions : The Aux. Inputs can be named as Emergency Stop, Battle, Lowe Frequency, Low Water Level, Low Fuel Level, Low Battery Volt, High Fuel Level, Pre-Alarm, charge fail, Over Load, Low Water Temp., and Spare.					

『Operation Switch』 Page

➤ Parameter Item

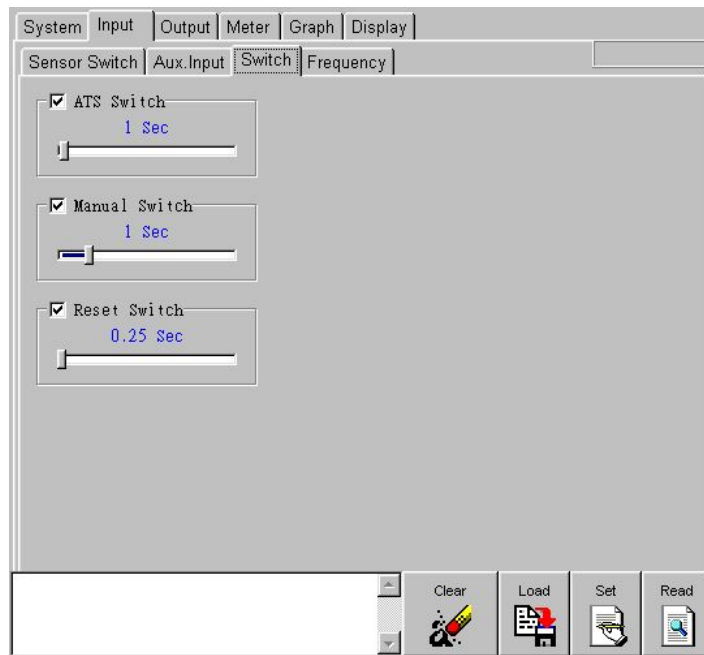

➤ Parameter Item

ATS Switch			
Parameter name	Default	Range	Description
Enable	Enable	Enable/Disable	Checked means enable this function.
Hold Time	1 Sec.	0.25 ~ 63.75	Minimum holding time.
Manual Switch			
Parameter name	Default	Range	Description
Enable	Enable	Enable/Disable	Checked means enable this function.
Hold Time	1 Sec.	0.25 ~ 5	Minimum holding time.
Reset Switch			
Parameter name	Default	Range	Description
Enable	Enable	Enable/Disable	Checked means enable this function.
Hold Time	0.25 Sec.	0.25 ~ 2.5	Minimum holding time.

『Frequency』 Page

➤ Parameter Screen

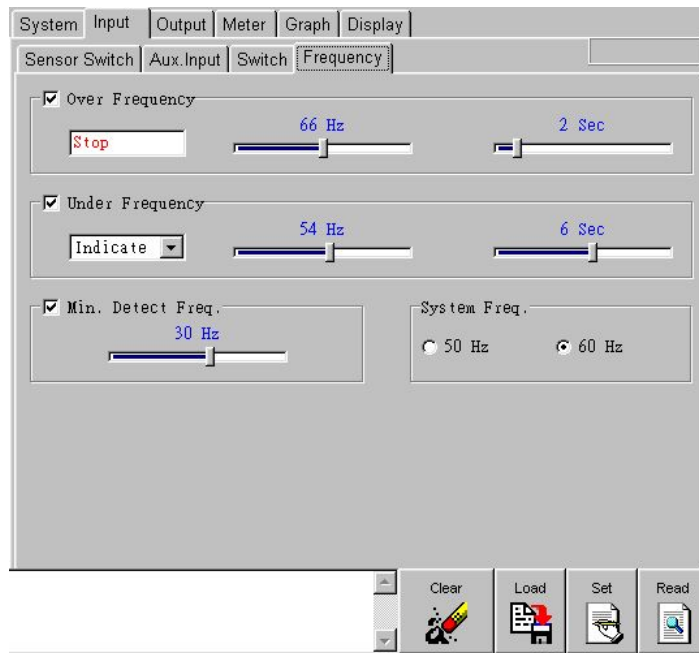

➤ Parameter Item

Over Frequency Parameter			
Parameter name	Default	Range	Description
Enable	Enable	Enable/Disable	Check means enable this function.
Action Mode	Shutdown	Shutdown	Shut down the engine after condition meets the set up value.
Frequency Setting (60 Hz)	66 Hz	60~72	This Range will be difference according to system frequency.
Frequency Setting (50 Hz)	55 Hz	50~60	
Delay Time	2 Sec.	1~10	Delay Time.
Under Frequency Parameter			
Parameter name	Default	Range	Description
Enable	Enable	Enable/Disable	Check means enable this function.
Action Mode	Indicate		Four kind action modes can be selected. Shut down, Trip, Alarm, Indicate.
Frequency Setting (60 Hz)	54 Hz	48~59	This range will be limited according to system frequency.
Frequency Setting (50 Hz)	45 Hz	40~50	

Delay Time	6 Sec.	1~10	Delay Time
Minimum Detect Frequency			
Parameter name	Default	Range	Description
Enable	Enable	Enable/Disable	Checked means enable this function.
Frequency Setting	30 Hz	10~45	Low frequency protection will be disabled when frequency is under this setting.
System Frequency			
Parameter name	Default	Range	Description
Frequency Setting	60 Hz	50、60	System rated frequency value

3、 『Output Relay』 Page

➤ Parameter Screen

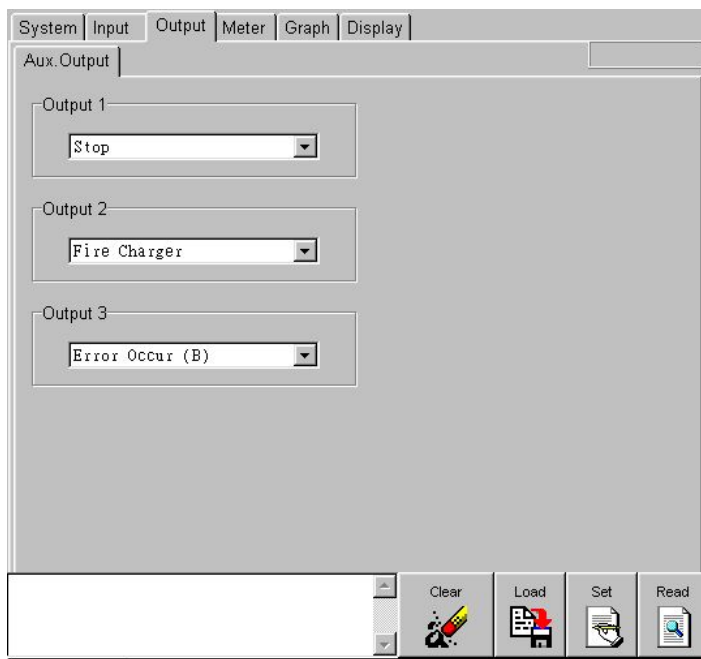

➤ Parameter Item

Auxiliary output Relay Faction			
Parameter name	Default	Range	Description
Output 1	Stop	See Description	(1) "Error Occur", (2) "Standby", (3) "Pre-heat", (4) "Start Period", (5) "Start Interval", (6) "Run", (7) "Stop", (8) "Engine Halt", (9) "Generator Working", (10) "Reset Activate", (11) "System Trip", (12) "System Alarm", (13) "Fire Charger", (14) "Reserve 1", (15) "Reserve 2", (16) "Reserve 3", (17) "Under Frequency Active", (18) "Reserve 4", (19) "Reserve 5", (20) "Reserve 6", (21) "Reserve 7", (22) "Error Occur (B)", (23) "Reserve 8", (24) "Spare", (25) "Engine Running", (26) "Low Battery Active", (27) "Reserve 9", (28) "Low Fuel Level Active", (29) "Over Crank", (30) "High Coolant Temp. Active", (31) "Over Speed Active", (32) "Low Lubr. Press. Active", (33) "Emergency Stop Active", (34) "Reserve 10", (35) "Reserve 11", (36) "Auto Start", (37) "Reserve 12", (38) "Reserve 13", (39) "Idle"
Output 2	Fire changer	See Description	
Output 3	Error Occur (B)	See Description	